

Male Cadet Contestants: 26

Round of 32 Round of 16 Quarterfinals Semifinals Final Semifinals Quarterfinals Round of 16 Round of 32

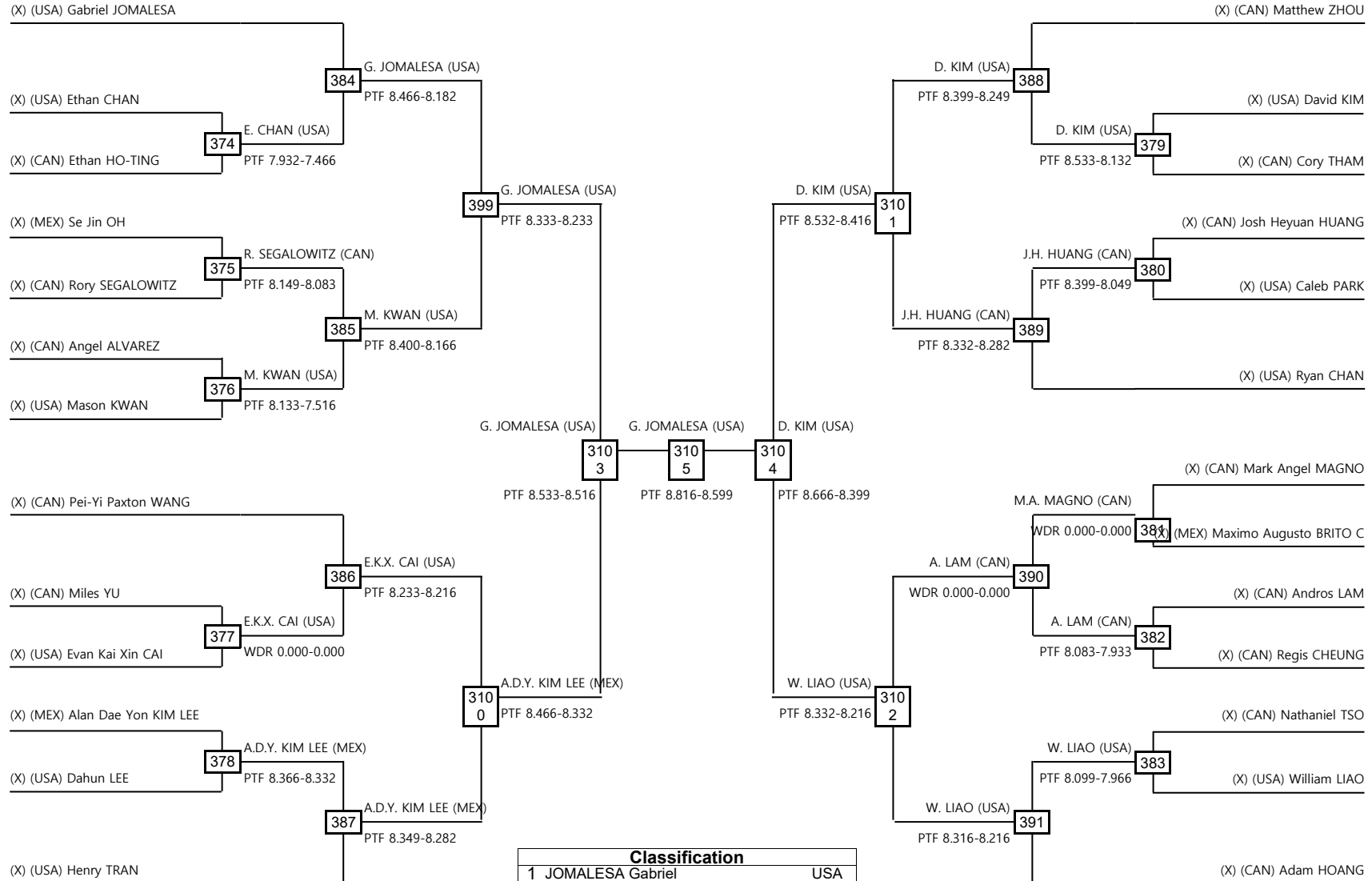

LEGEND
(x): Seed PTF: Win by final score WDR: Win by Withdrawal

Male Junior Contestants: 26

Round of 32 Round of 16 Quarterfinals Semifinals Final Semifinals Quarterfinals Round of 16 Round of 32

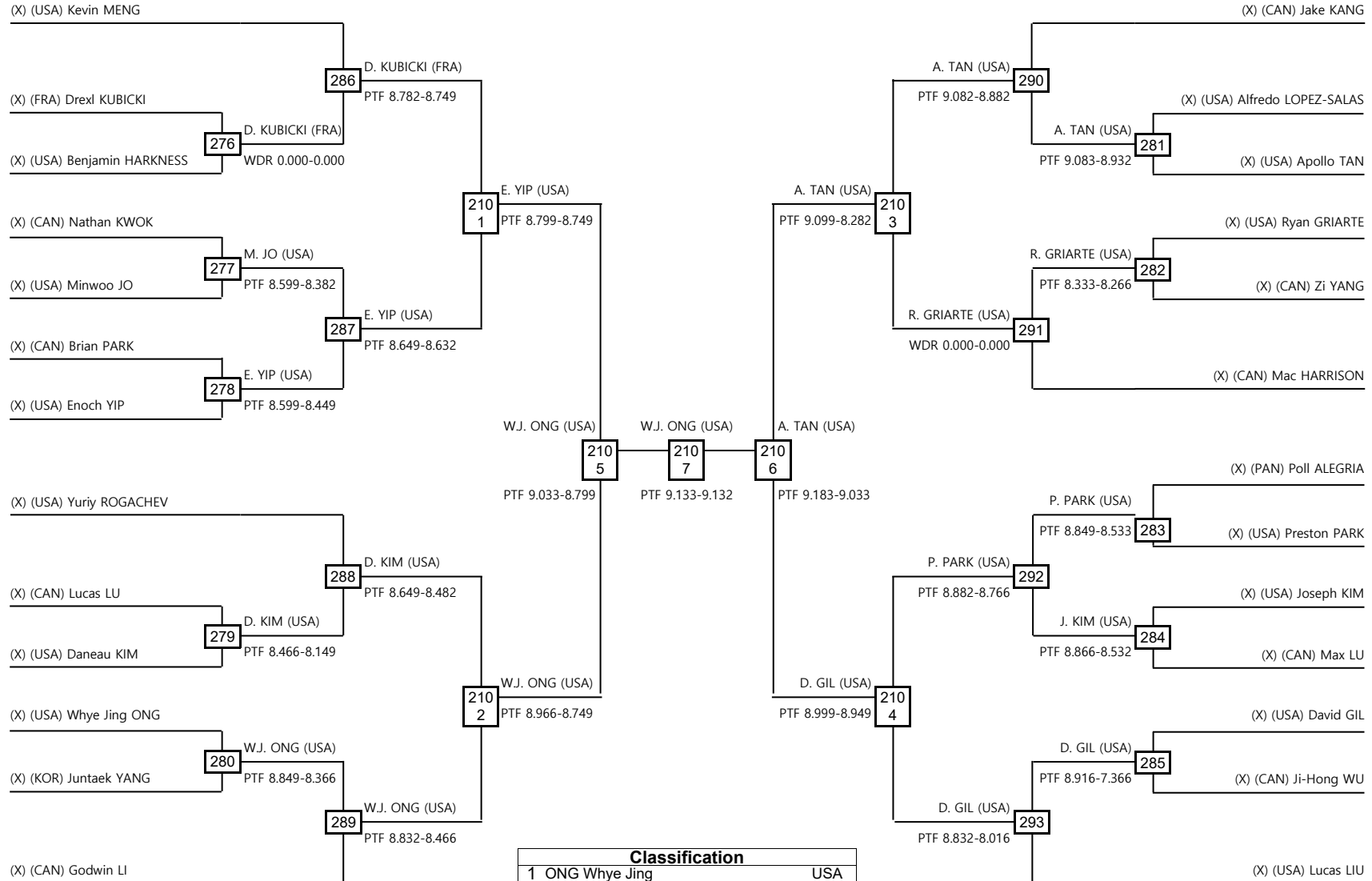

LEGEND
(x): Seed PTF: Win by final score WDR: Win by Withdrawal

Male Under 30 Contestants: 29

Round of 32 Round of 16 Quarterfinals Semifinals Final Semifinals Quarterfinals Round of 16 Round of 32

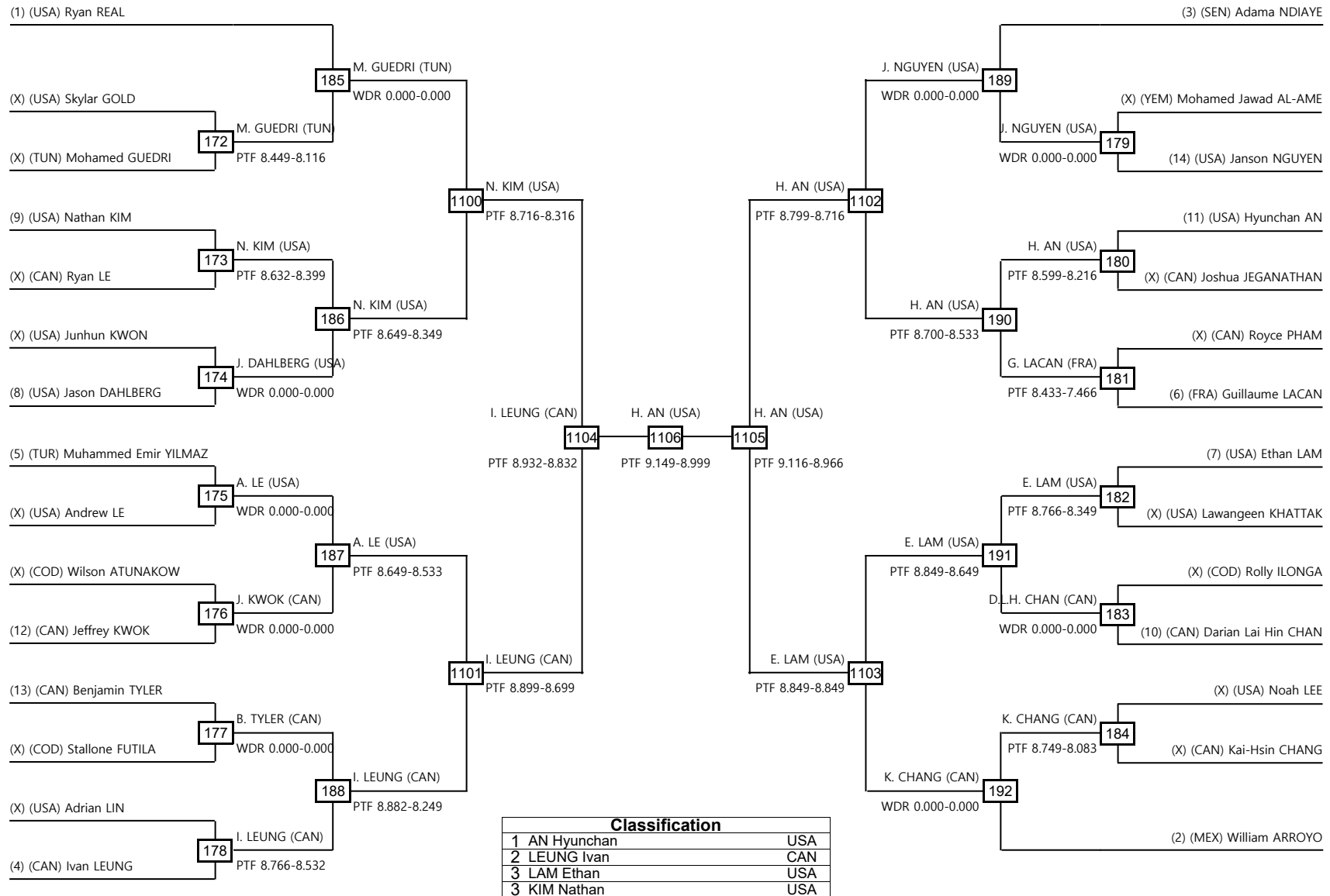

LEGEND

(x): Seed PTF: Win by final score

WDR: Win by Withdrawal

Male Under 40 Contestants: 23

Round of 32 Round of 16 Quarterfinals Semifinals Final Semifinals Quarterfinals Round of 16 Round of 32

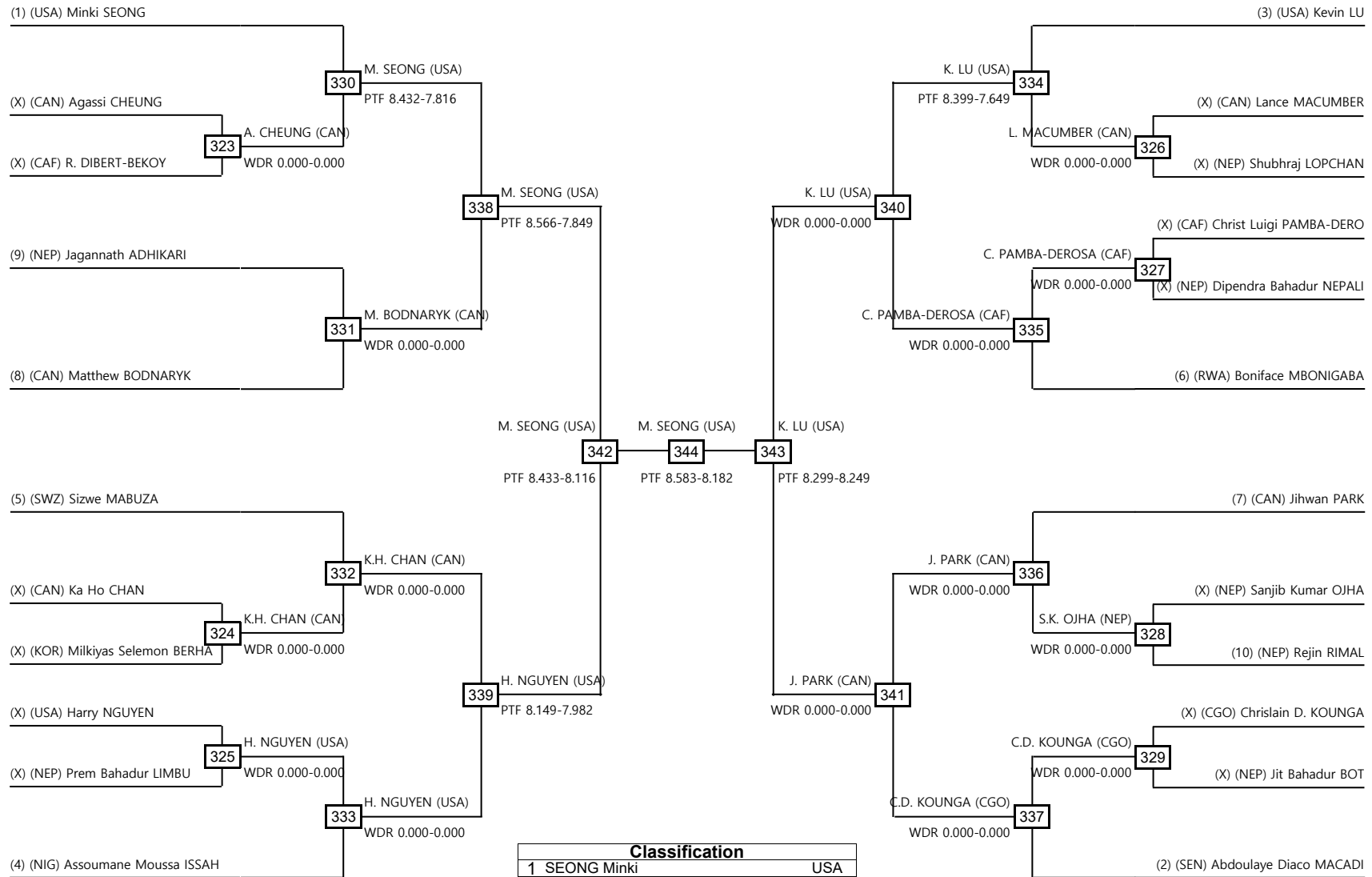

Classification	
1	SEONG Minki USA
2	LU Kevin USA
3	PARK Jihwan CAN
3	NGUYEN Harry USA

LEGEND

(x): Seed PTF: Win by final score

WDR: Win by Withdrawal

Male Under 50 Contestants: 5

Quarterfinals Semifinals Final Semifinals Quarterfinals

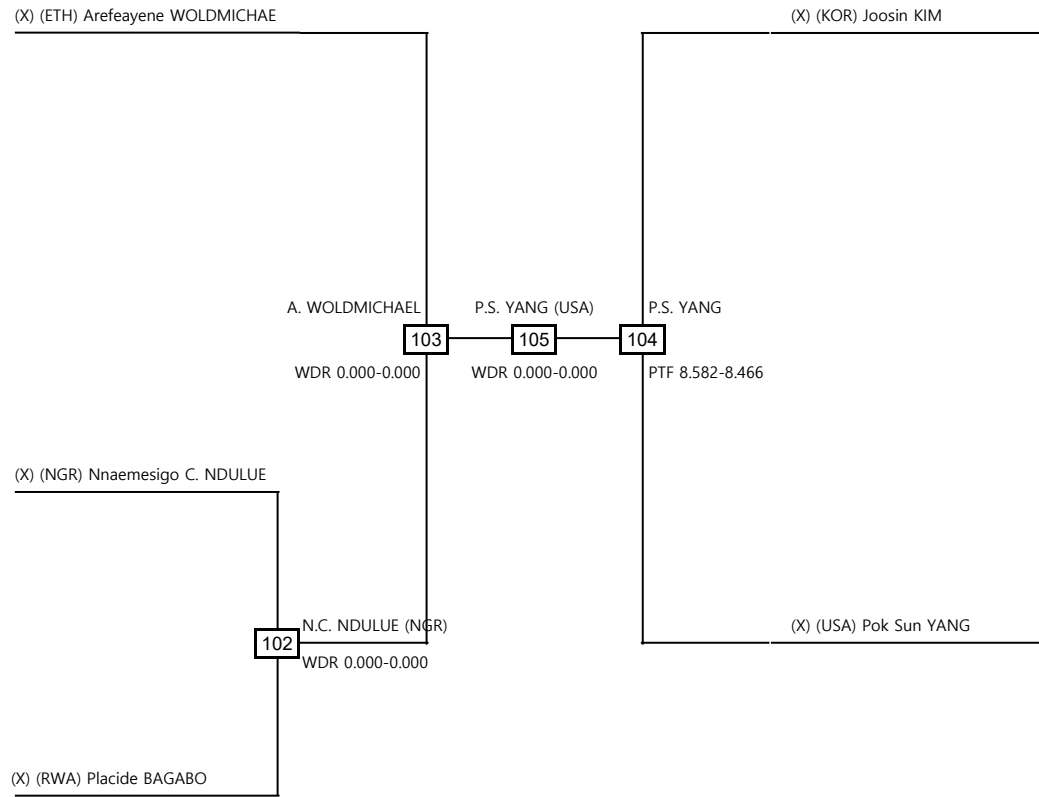

Classification	
1	YANG Pok Sun USA
2	KIM Joosin KOR
3	
3	

LEGEND
(x): Seed PTF: Win by final score

WDR: Win by Withdrawal

Male Under 60 Contestants: 9

Round of 16 Quarterfinals Semifinals Final Semifinals Quarterfinals Round of 16

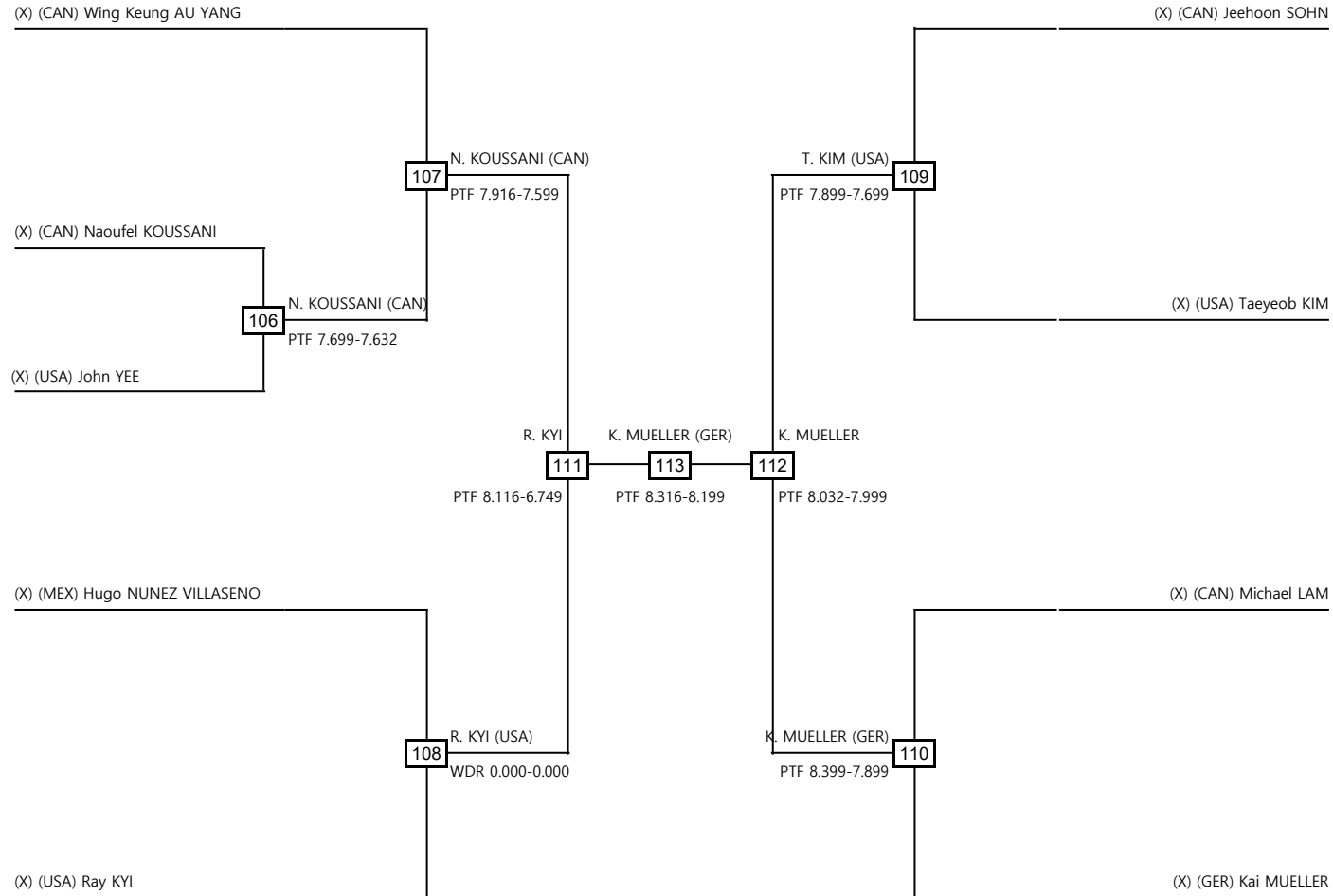

Classification	
1	MUELLER Kai GER
2	KYI Ray USA
3	KIM Taeyeob USA
3	KOUSSANI Naoufel CAN

LEGEND

(x): Seed PTF: Win by final score

WDR: Win by Withdrawal

Final

Pietro DE CUBELLIS

Pietro DE CUBELLIS

101

PTF 0.199-0.099

Classification

1	DE CUBELLIS Pietro	CAN
2		
3		
3		

LEGEND

(x): Seed PTF: Win by final score

WDR: Win by Withdrawal

Male Over 65 Contestants: 4

Semifinals Final Semifinals

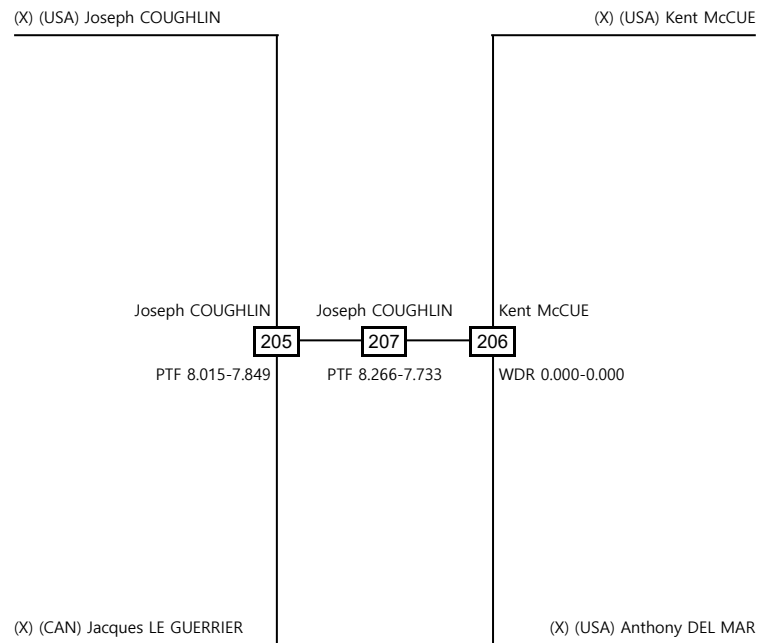

Classification		
1	COUGHLIN Joseph	USA
2	McCUE Kent	USA
3	LE GUERRIER Jacques	CAN
3		

LEGEND

(x): Seed PTF: Win by final score

WDR: Win by Withdrawal

Female Cadet Contestants: 37

Round of 64 Round of 32 Round of 16 Quarterfinals Semifinals Final Semifinals Quarterfinals Round of 16 Round of 32 Round of 64

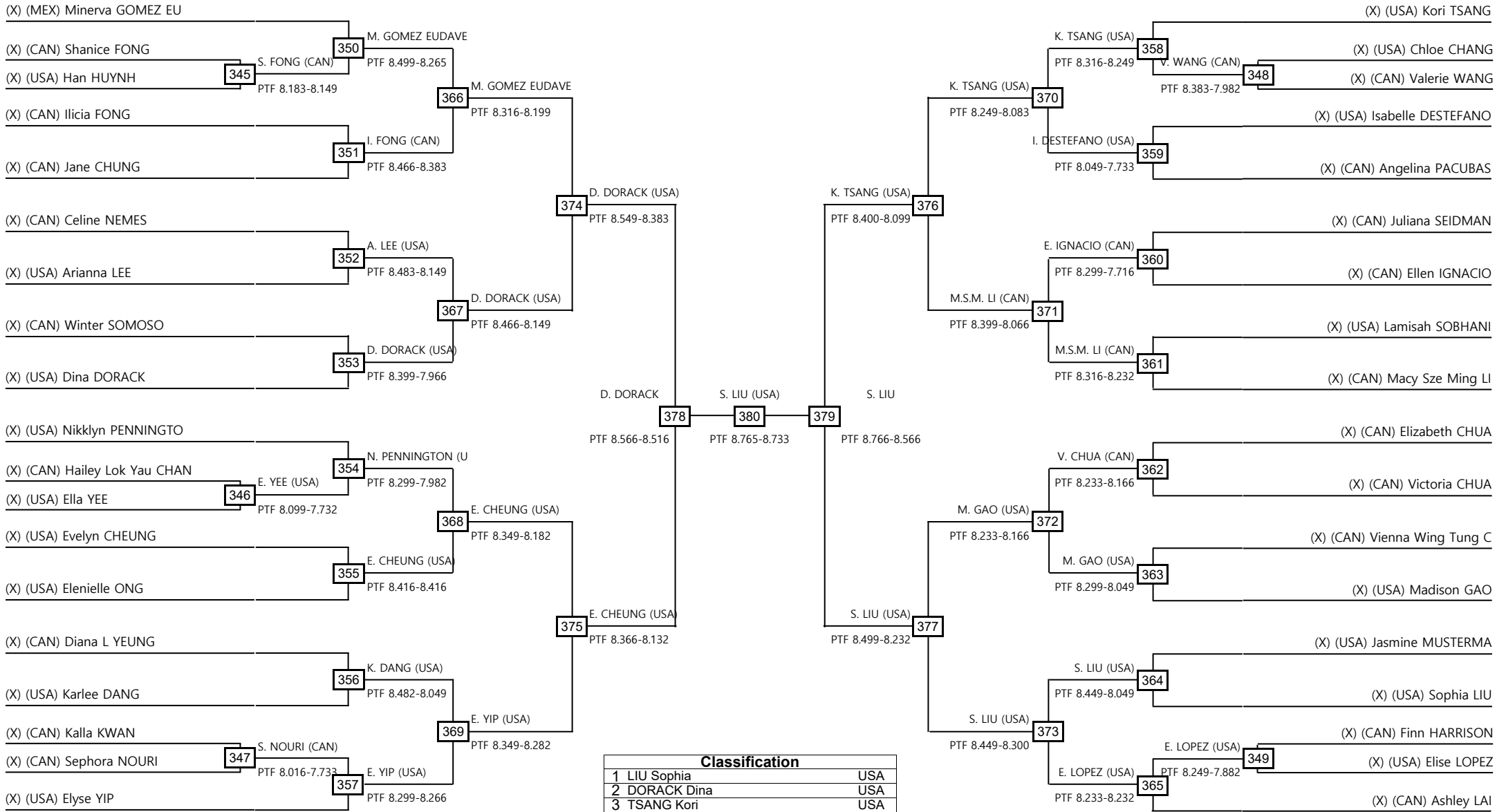

LEGEND
(x): Seed PTF: Win by final score WDR: Win by Withdrawal

Female Junior Contestants: 38

Round of 64 Round of 32 Round of 16 Quarterfinals Semifinals Final Semifinals Quarterfinals Round of 16 Round of 32 Round of 64

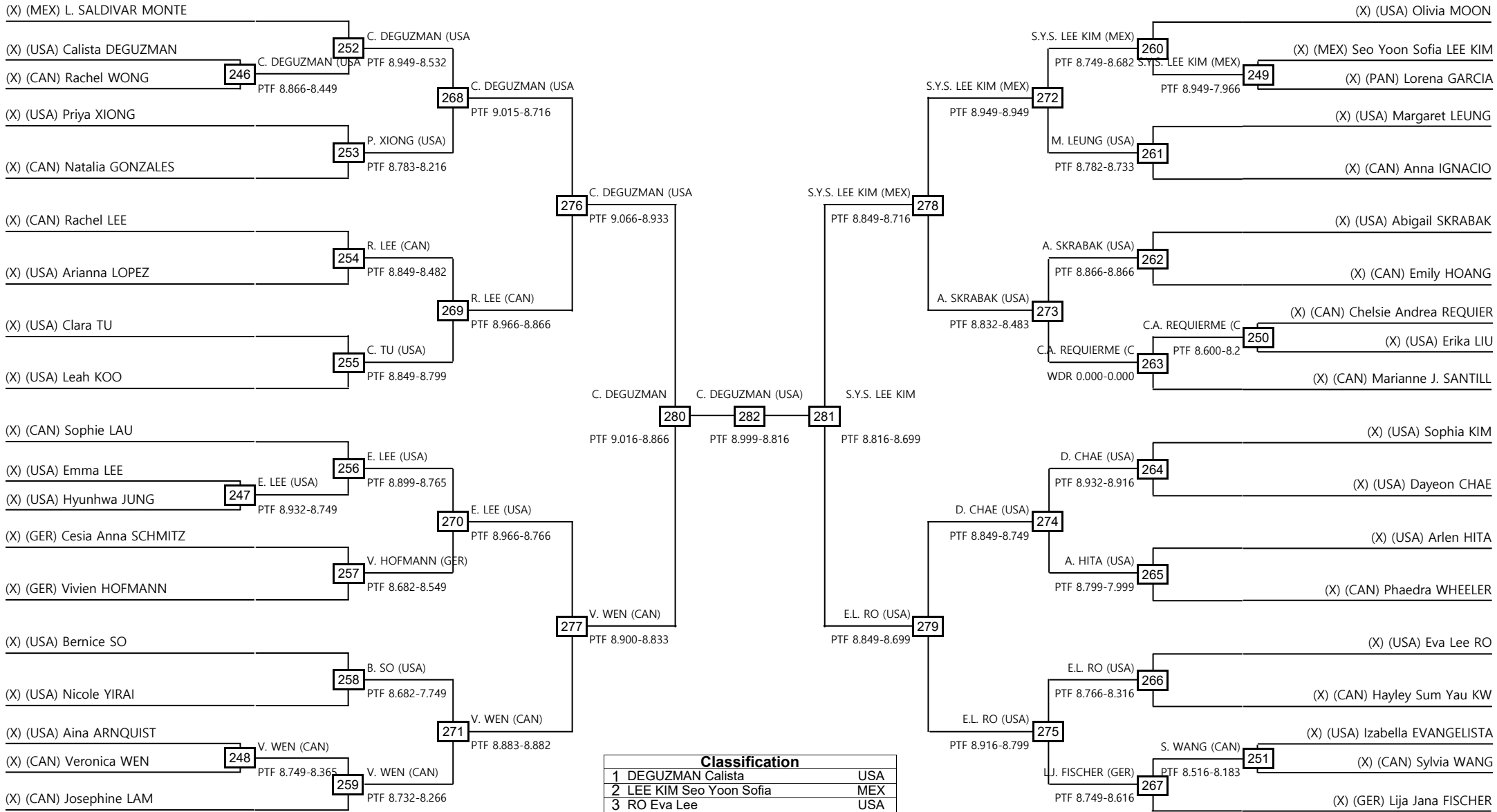

LEGEND
(x): Seed PTF: Win by final score WDR: Win by Withdrawal

Female Under 30 Contestants: 38

Round of 64 Round of 32 Round of 16 Quarterfinals Semifinals Final Semifinals Quarterfinals Round of 16 Round of 32 Round of 64

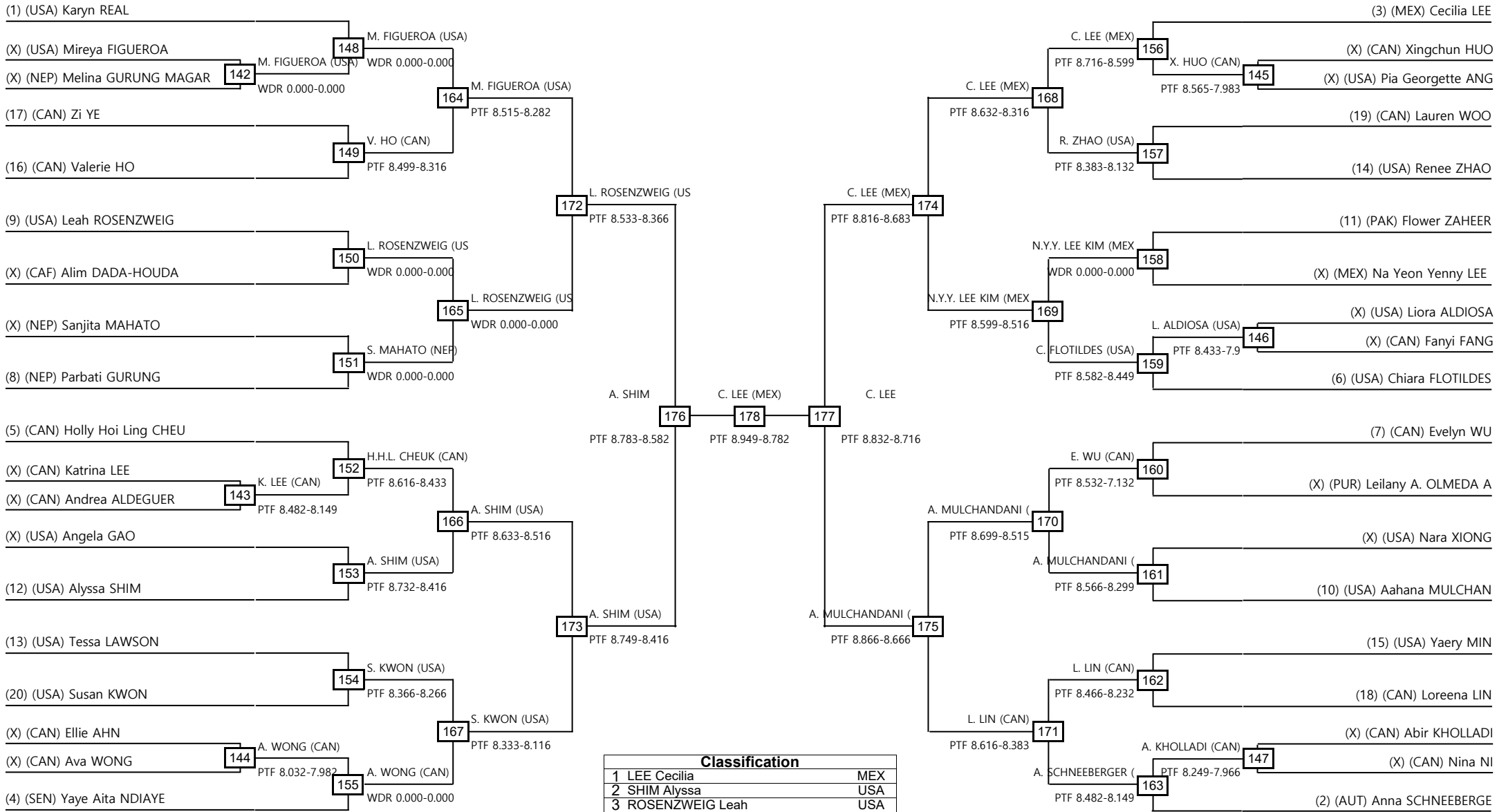

LEGEND
 (x): Seed PTF: Win by final score WDR: Win by Withdrawal

Female Under 40 Contestants: 17

Round of 32 Round of 16 Quarterfinals Semifinals Final Semifinals Quarterfinals Round of 16 Round of 32

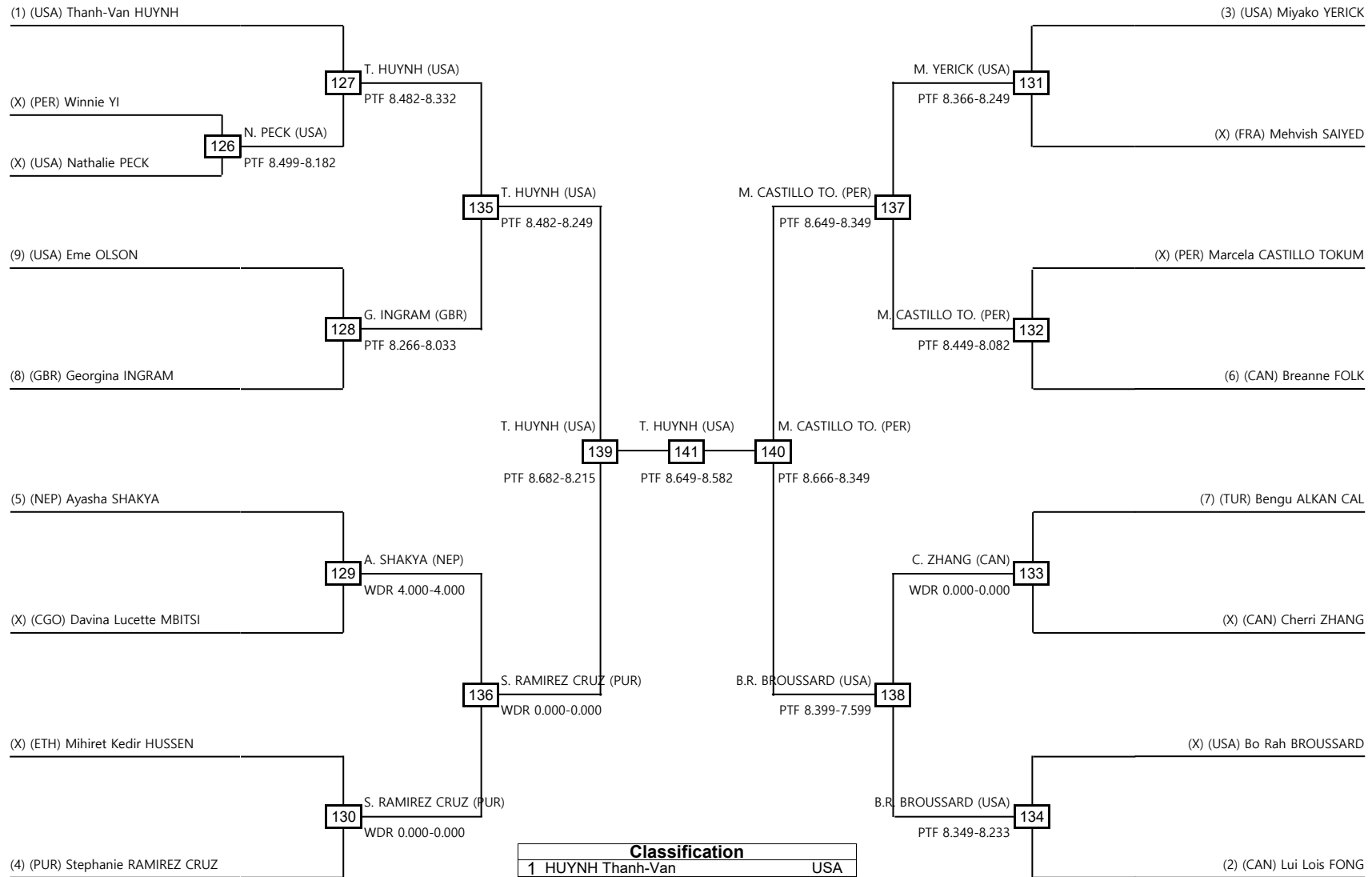

LEGEND

(x): Seed PTF: Win by final score

WDR: Win by Withdrawal

Female Under 60 Contestants: 7

Quarterfinals Semifinals Final Semifinals Quarterfinals

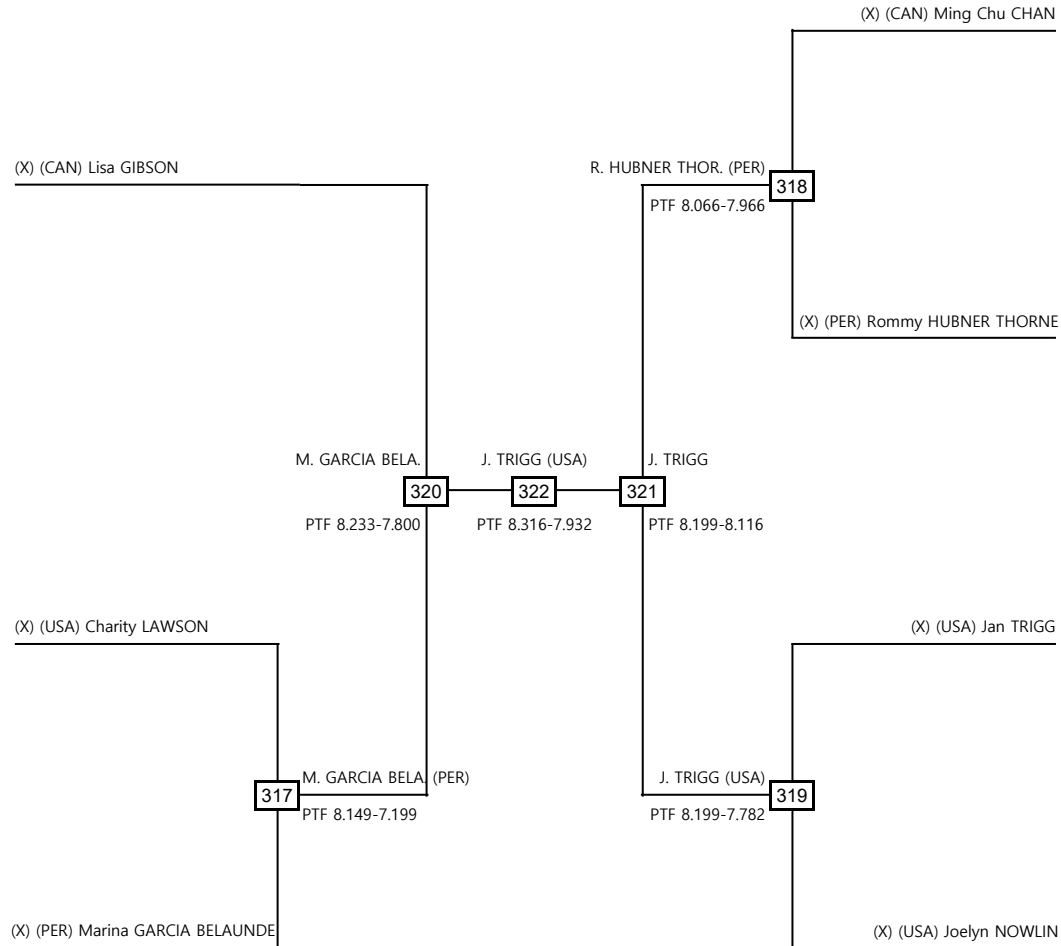

Classification		
1	TRIGG Jan	USA
2	GARCIA BELAUNDE VELARDE Mari	PER
3	HUBNER THORNE Rommy	PER
3	GIBSON Lisa	CAN

LEGEND

(x): Seed PTF: Win by final score

WDR: Win by Withdrawal

Female Under 65 Contestants: 3

Semifinals Final Semifinals

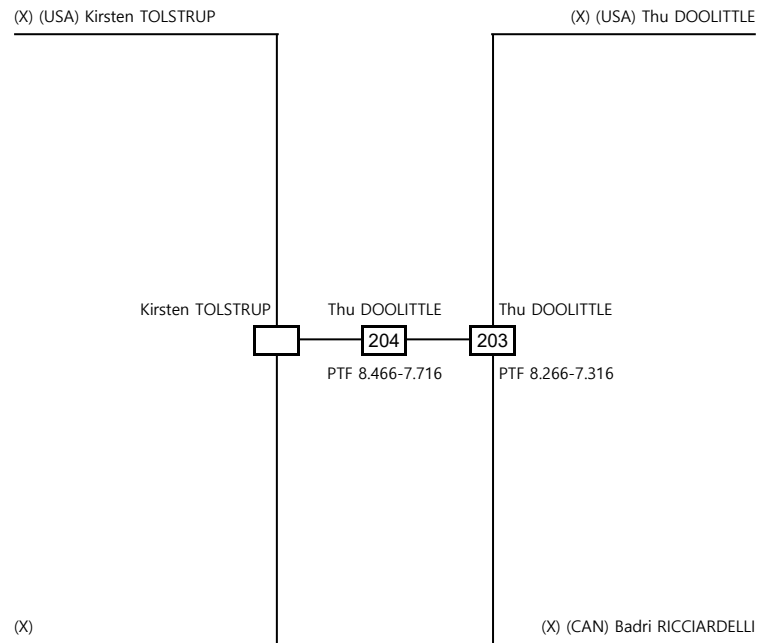

Classification		
1	DOOLITTLE Thu	USA
2	TOLSTRUP Kirsten	USA
3	RICCIARDELLI Badri	CAN
3		

LEGEND

(x): Seed PTF: Win by final score

WDR: Win by Withdrawal

Female Over 65 Contestants: 5

Quarterfinals Semifinals Final Semifinals Quarterfinals

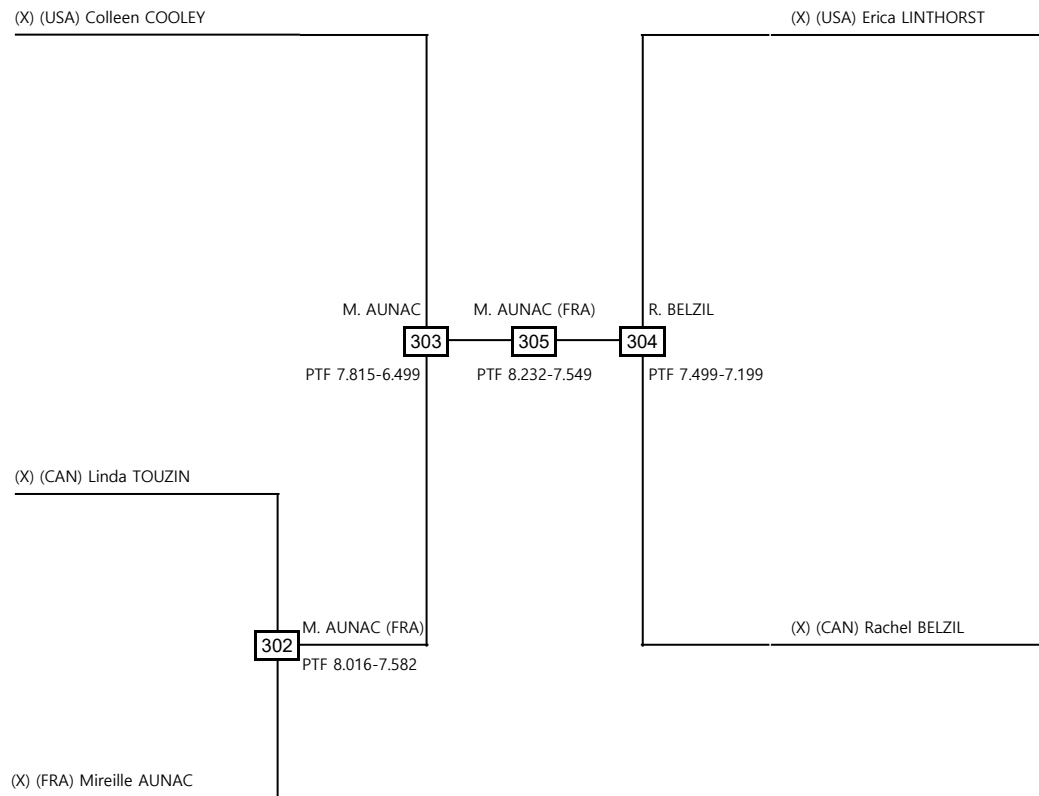

Classification	
1	AUNAC Mireille FRA
2	BELZIL Rachel CAN
3	LINTHORST Erica USA
3	COOLEY Colleen USA

LEGEND

(x): Seed PTF: Win by final score

WDR: Win by Withdrawal

Pair Cadet Contestants: 9

Round of 16 Quarterfinals Semifinals Final Semifinals Quarterfinals Round of 16

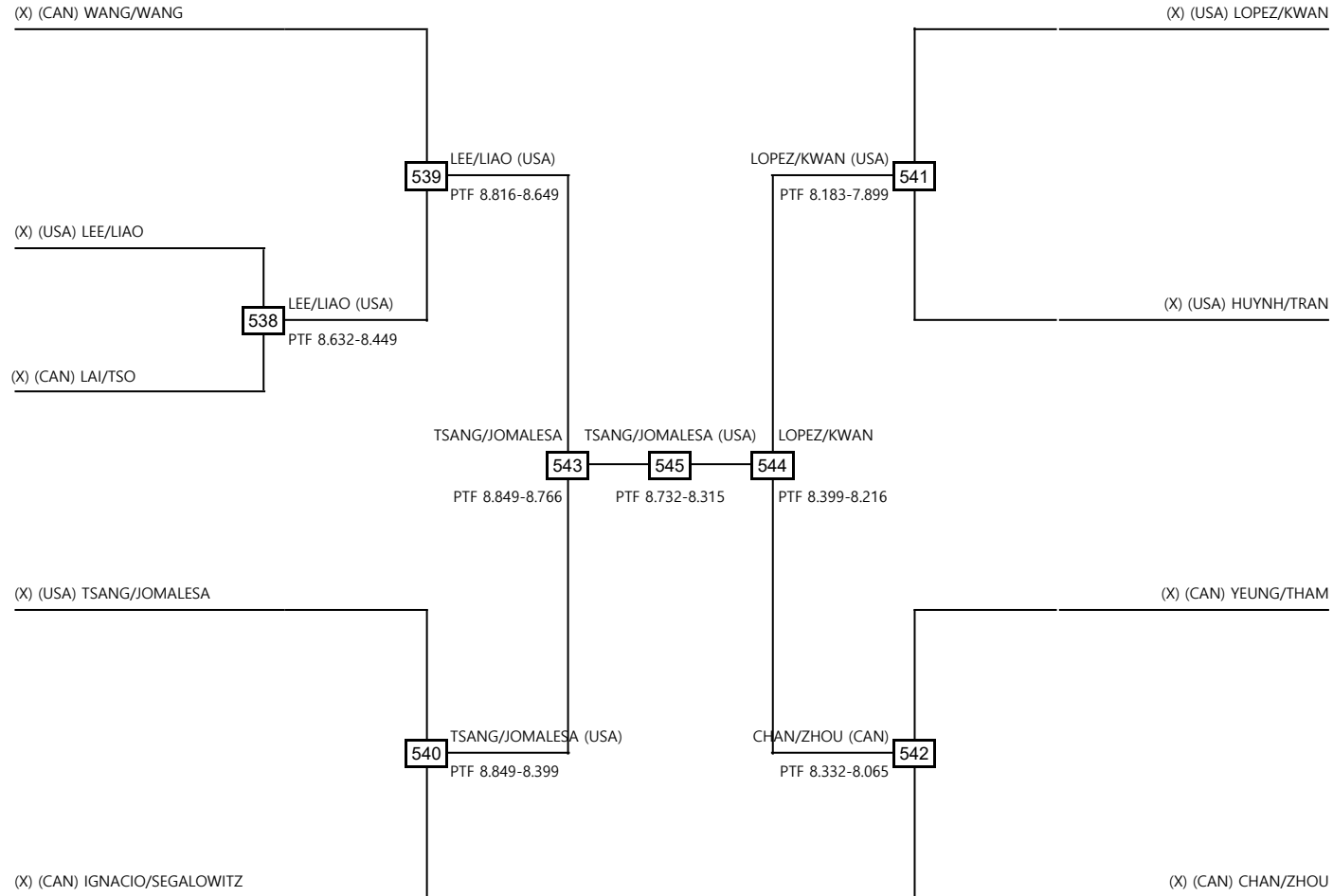

Classification	
1	TSANG/JOMALESA USA
2	LOPEZ/KWAN USA
3	LEE/LIAO USA
3	CHAN/ZHOU CAN

LEGEND

(x): Seed PTF: Win by final score

WDR: Win by Withdrawal

Pair Junior Contestants: 16

Round of 16 Quarterfinals Semifinals Final Semifinals Quarterfinals Round of 16

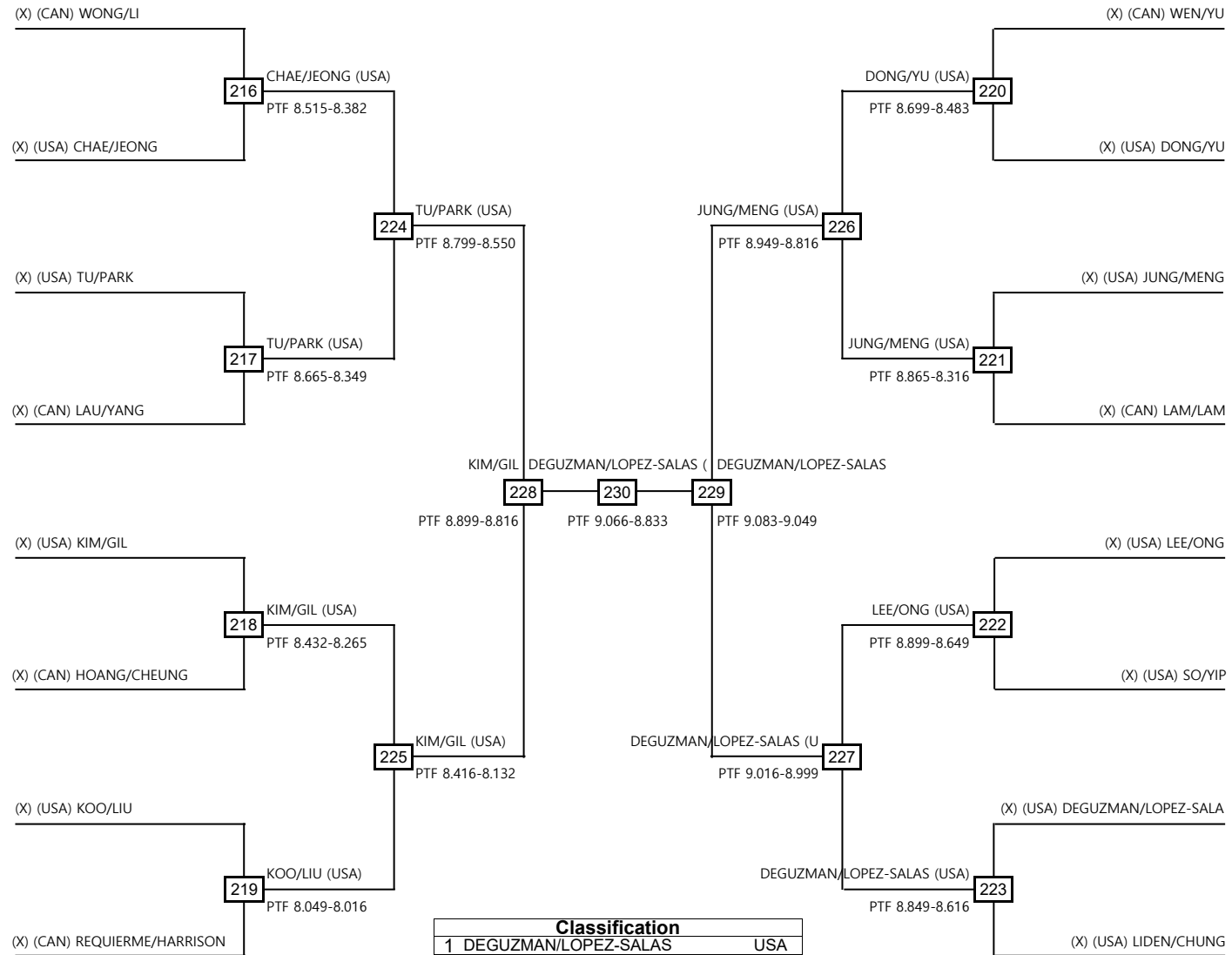

LEGEND
(x): Seed PTF: Win by final score

WDR: Win by Withdrawal

Pair Under 30 Contestants: 7

Quarterfinals Semifinals Final Semifinals Quarterfinals

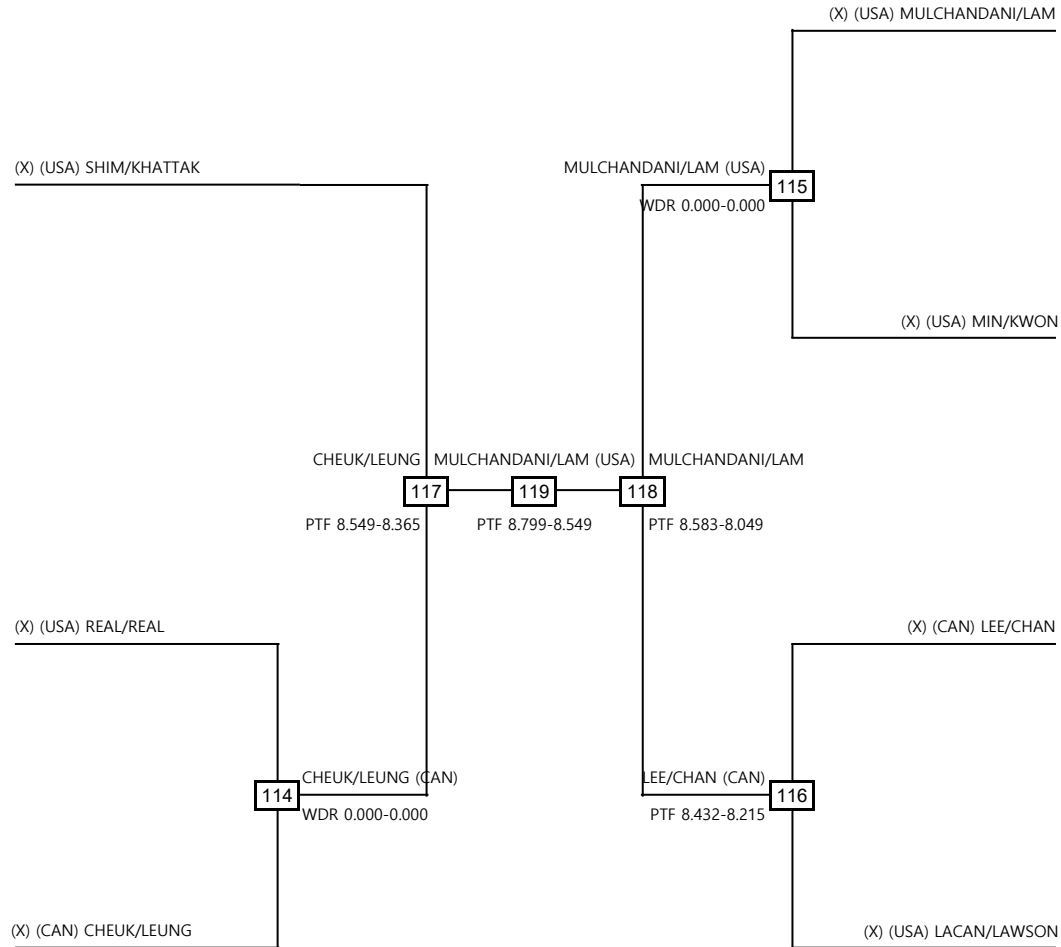

Classification	
1	MULCHANDANI/LAM USA
2	CHEUK/LEUNG CAN
3	SHIM/KHATTAK USA
3	LEE/CHAN CAN

LEGEND

(x): Seed PTF: Win by final score

WDR: Win by Withdrawal

Pair Under 50 Contestants: 7

Quarterfinals Semifinals Final Semifinals Quarterfinals

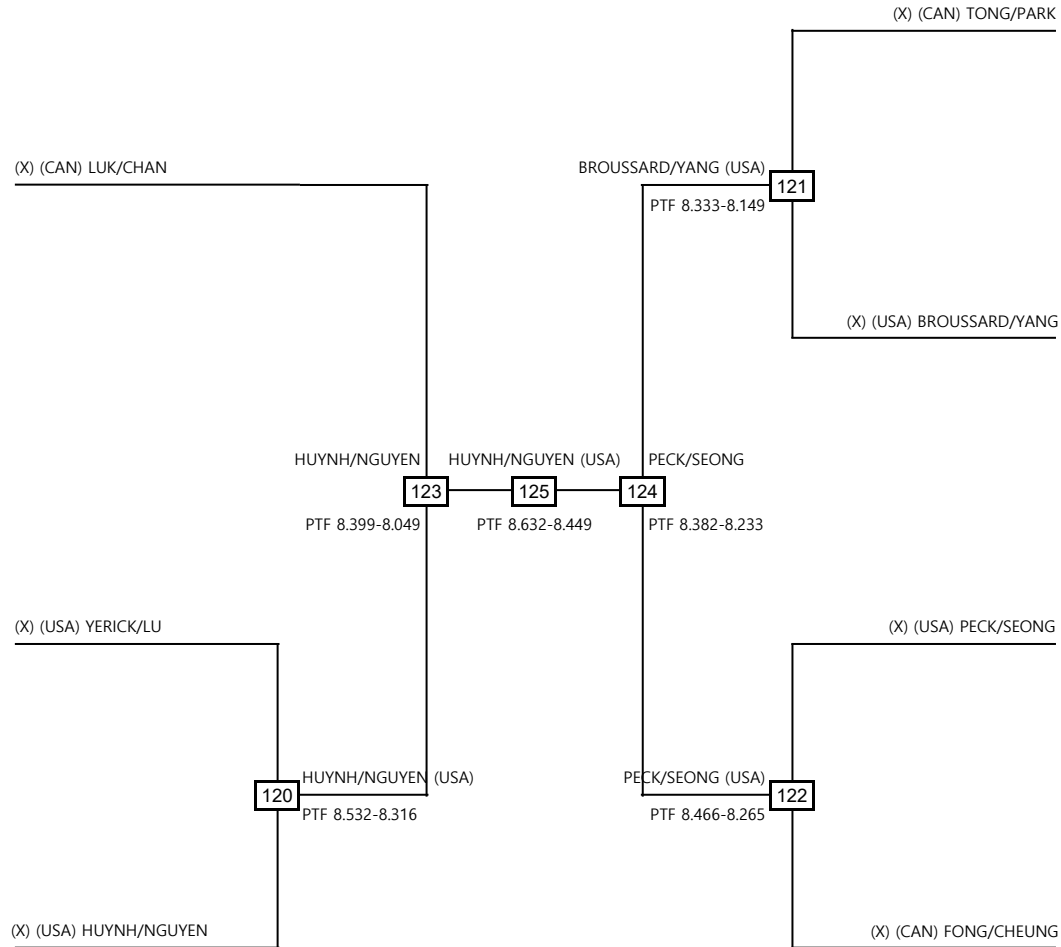

Classification	
1	HUYNH/NGUYEN USA
2	PECK/SEONG USA
3	BROUSSARD/YANG USA
3	LUK/CHAN CAN

LEGEND

(x): Seed PTF: Win by final score

WDR: Win by Withdrawal

Final

COUGHLIN/HISLOP

COUGHLIN/HISLOP

202

PTF 7.499-4.000

Classification

1	COUGHLIN/HISLOP	USA
2		
3		
3		

LEGEND

(x): Seed PTF: Win by final score

WDR: Win by Withdrawal

Male Team Cadet Contestants: 4

Semifinals Final Semifinals

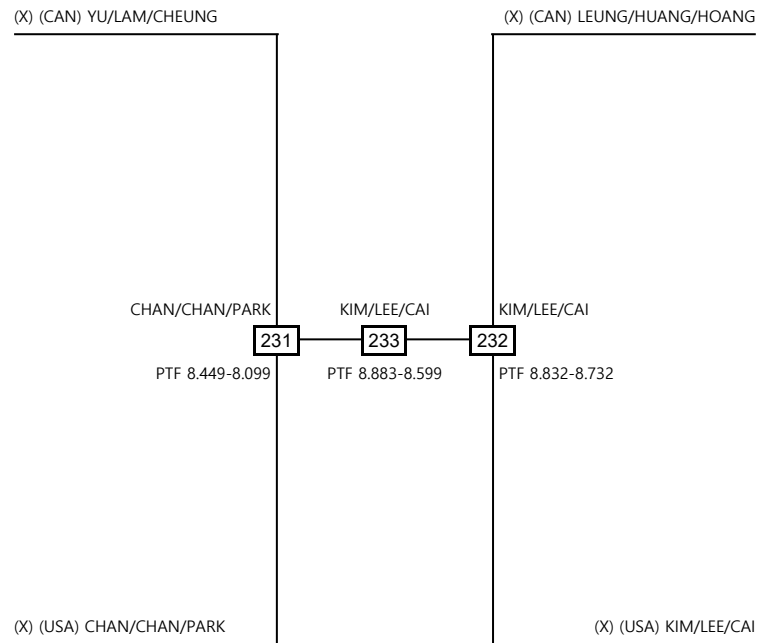

Classification		
1	KIM/LEE/CAI	USA
2	CHAN/CHAN/PARK	USA
3	YU/LAM/CHEUNG	CAN
3	LEUNG/HUANG/HOANG	CAN

LEGEND

(x): Seed PTF: Win by final score

WDR: Win by Withdrawal

Male Team Junior Contestants: 4

Semifinals Final Semifinals

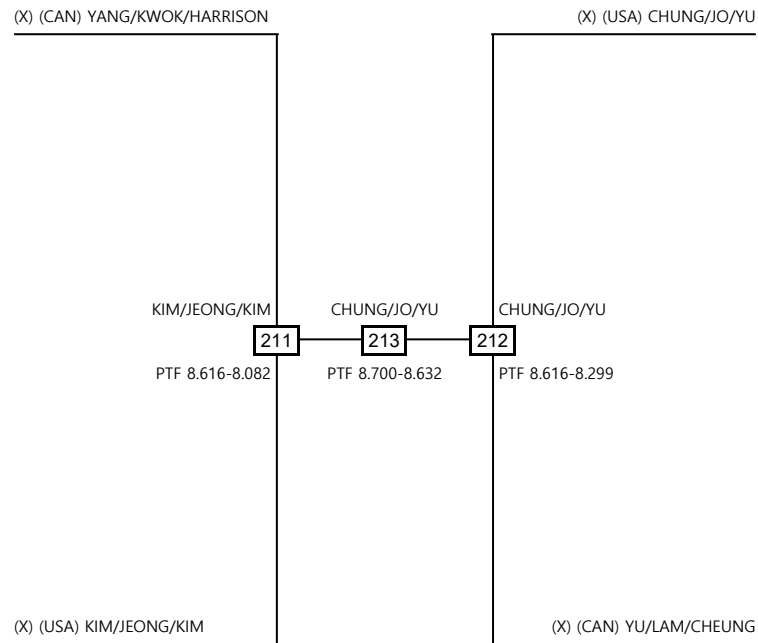

Classification		
1	CHUNG/JO/YU	USA
2	KIM/JEONG/KIM	USA
3	YANG/KWOK/HARRISON	CAN
3	YU/LAM/CHEUNG	CAN

LEGEND

(x): Seed PTF: Win by final score

WDR: Win by Withdrawal

Male Team Under 30 Contestants: 2

Final

KIM/GOLD/LEE LE/AN/KIM LE/AN/KIM

208

PTF 8.782-7.766

Classification		
1	LE/AN/KIM	USA
2	KIM/GOLD/LEE	USA
3		
3		

LEGEND

(x): Seed PTF: Win by final score

WDR: Win by Withdrawal

Female Team Cadet Contestants: 5

Quarterfinals Semifinals Final Semifinals Quarterfinals

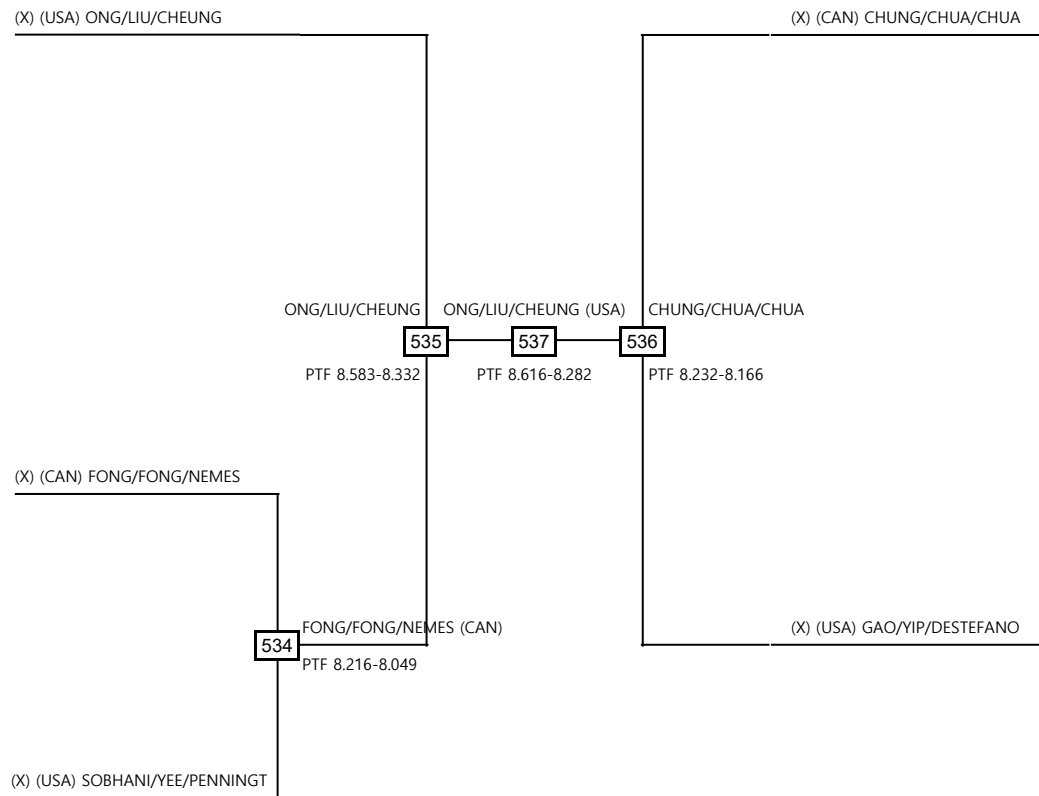

Classification	
1	ONG/LIU/CHEUNG USA
2	CHUNG/CHUA/CHUA CAN
3	FONG/FONG/NEMES CAN
3	GAO/YIP/DESTEFANO USA

LEGEND
(x): Seed PTF: Win by final score

WDR: Win by Withdrawal

Female Team Junior Contestants: 3

Semifinals Final Semifinals

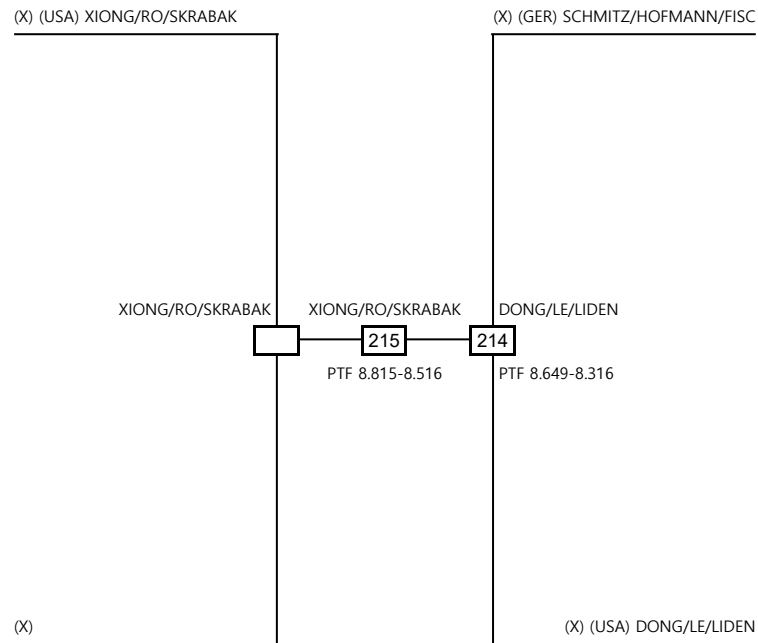

Classification		
1	XIONG/RO/SKRABAK	USA
2	DONG/LE/LIDEN	USA
3	SCHMITZ/HOFMANN/FISCHER	GER
3		

LEGEND

(x): Seed PTF: Win by final score

WDR: Win by Withdrawal

Female Team Under 30 Contestants: 3

Semifinals Final Semifinals

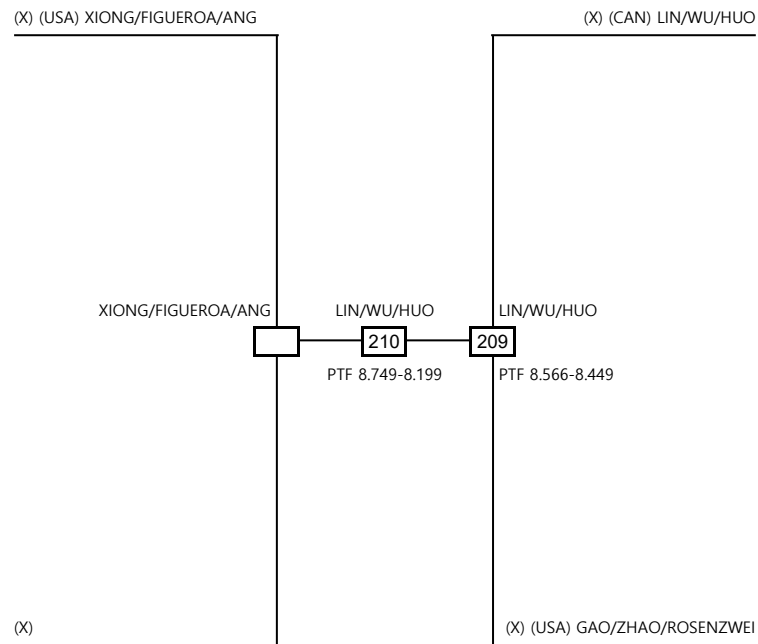

Classification	
1	LIN/WU/HUO CAN
2	XIONG/FIGUEROA/ANG USA
3	GAO/ZHAO/ROSENZWEIG USA
3	

LEGEND

(x): Seed PTF: Win by final score

WDR: Win by Withdrawal

Female Team Under 50 Contestants: 2

Final

ZACH/ERICKSON/OLSON

ZACH/ERICKSON/OLSON

301

PTF 7.449-1.500

Classification

1	ZACH/ERICKSON/OLSON	USA
2		
3		
3		

LEGEND

(x): Seed PTF: Win by final score

WDR: Win by Withdrawal

Female Team Over 60 Contestants: 2

Final

LINTHORST/COOLEY/HISLOP LINTHORST/COOLEY/HISLOP

201

PTF 4.000-4.000

Classification

1	LINTHORST/COOLEY/HISLOP	USA
2		
3		
3		

LEGEND

(x): Seed PTF: Win by final score

WDR: Win by Withdrawal

Contest Results
2025 Canada Open
Final Male Under 17
As of 08 FEB 2025

Rank	Contest No	NOC	Name	Score	Acc/Tech	Total	Detail					
					Pre		Game	Score	Acc/Tech	Pre	Total	Deduct
1	1109	MEX	KIM LEE Alan Dae Yon	7.566	4.300	37.2	Game1	7.566	4.300	3.266	37.2	0.0
					3.266		Game2	0.000	0.000	0.000	0.0	0.0
2	1108	CAN	KANG Jake	7.333	4.333	35.7	Game1	7.333	4.333	3.000	35.7	0.0
					3.000		Game2	0.000	0.000	0.000	0.0	0.0
3	1107	USA	WONG James	7.032	4.166	34.8	Game1	7.032	4.166	2.866	34.8	0.0
					2.866		Game2	0.000	0.000	0.000	0.0	0.0
4	1110	USA	MIN Joel	6.132	3.566	30.8	Game1	6.132	3.566	2.566	30.8	0.0
					2.566		Game2	0.000	0.000	0.000	0.0	0.0

Contest Results
2025 Canada Open
Final Male Over 17
As of 08 FEB 2025

Rank	Contest No	NOC	Name	Score	Acc/Tech	Total	Detail					
					Pre		Game	Score	Acc/Tech	Pre	Total	Deduct
1	3108	CAN	CHANG Kai-Hsin	8.633	5.200	43.3	Game1	8.633	5.200	3.433	43.3	0.0
					3.433		Game2	0.000	0.000	0.000	0.0	0.0
2	3111	USA	DAHLBERG Jason	7.533	4.533	36.1	Game1	7.533	4.533	3.000	36.1	0.0
					3.000		Game2	0.000	0.000	0.000	0.0	0.0
3	3104	USA	LIN Adrian	7.466	4.533	36.4	Game1	7.466	4.533	2.933	36.4	0.0
					2.933		Game2	0.000	0.000	0.000	0.0	0.0
4	3110	GER	MULLER Julius	6.333	3.600	32.0	Game1	6.333	3.600	2.733	32.0	0.0
					2.733		Game2	0.000	0.000	0.000	0.0	0.0
5	3107	USA	KIM Noah	5.366	3.200	28.5	Game1	5.666	3.200	2.466	28.5	0.3
					2.466		Game2	0.000	0.000	0.000	0.0	0.0
1000	3103	EGY	ALI MUHAMMED SHAALAN Alhussein	0.000	0.000	0.0	Game1	0.000	0.000	0.000	0.0	0.0
					0.000		Game2	0.000	0.000	0.000	0.0	0.0
1000	3105	KSA	AL HANAHI Ezzaldeen Muaadh	0.000	0.000	0.0	Game1	0.000	0.000	0.000	0.0	0.0
					0.000		Game2	0.000	0.000	0.000	0.0	0.0

Contest Results
2025 Canada Open
Final Male Over 17
As of 08 FEB 2025

Rank	Contest No	NOC	Name	Score	Acc/Tech	Total	Detail					
					Pre		Game	Score	Acc/Tech	Pre	Total	Deduct
1000	3106	TUR	YILMAZ Muhammed Emir	0.000	0.000	0.0	Game1	0.000	0.000	0.000	0.0	0.0
					0.000		Game2	0.000	0.000	0.000	0.0	0.0
1000	3112	MEX	ARROYO William	0.000	0.000	0.0	Game1	0.000	0.000	0.000	0.0	0.0
					0.000		Game2	0.000	0.000	0.000	0.0	0.0
1000	3109	EGY	AHMED THABET ELSAYED Muhammad	0.000	0.000	0.0	Game1	0.000	0.000	0.000	0.0	0.0
					0.000		Game2	0.000	0.000	0.000	0.0	0.0

Contest Results
2025 Canada Open
Final Female Under 17
As of 08 FEB 2025

Rank	Contest No	NOC	Name	Score	Acc/Tech	Total	Detail					
					Pre		Game	Score	Acc/Tech	Pre	Total	Deduct
1	2112	CAN	LEE Rachel	7.466	4.566	37.9	Game1	7.766	4.566	3.200	37.9	0.3
					3.200		Game2	0.000	0.000	0.000	0.0	0.0
2	2109	MEX	GOMEZ EUDAVE Minerva	6.900	4.000	34.8	Game1	6.900	4.000	2.900	34.8	0.0
					2.900		Game2	0.000	0.000	0.000	0.0	0.0
3	2110	USA	HITA Arlen	6.233	3.533	31.2	Game1	6.233	3.533	2.700	31.2	0.0
					2.700		Game2	0.000	0.000	0.000	0.0	0.0
4	2113	USA	MOON Olivia	5.899	3.233	30.0	Game1	5.899	3.233	2.666	30.0	0.0
					2.666		Game2	0.000	0.000	0.000	0.0	0.0
1000	2111	USA	NA Glenda	0.000	0.000	0.0	Game1	0.000	0.000	0.000	0.0	0.0
					0.000		Game2	0.000	0.000	0.000	0.0	0.0



**Contest Results
2025 Canada Open
Final Pair Under 17
As of 08 FEB 2025**



Rank	Contest No	NOC	Name	Score	Acc/Tech	Total	Detail					
					Pre		Game	Score	Acc/Tech	Pre	Total	Deduct
1	2108	CAN	LI/LEUNG	6.799	3.866	34.1	Game1	6.799	3.866	2.933	34.1	0.0
					2.933		Game2	0.000	0.000	0.000	0.0	0.0

